

MODEL: IG10600013-1113

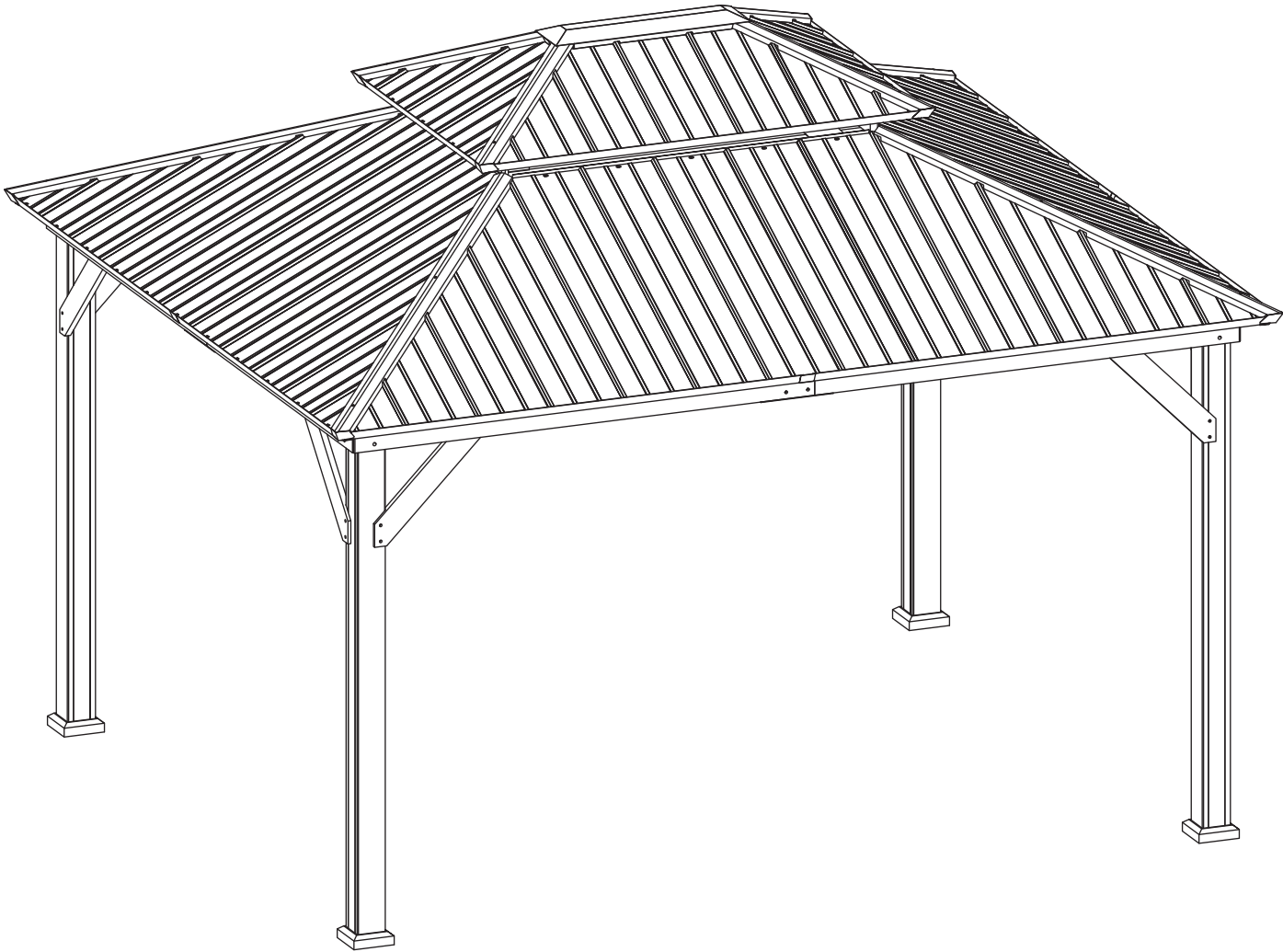

OWNER'S MANUAL

Rosewood 11' x 13' Cedar Framed Hard Top Gazebo

TABLE OF CONTENTS

ASSEMBLY GUIDE.....02
USING YOUR PRODUCT.....05

December 17, 2024

QUESTIONS?



 **E-mail:** support@modernshade.org



 **Toll Free:** 1-888-666-3070

 **Mon-Fri:** 9am---5pm PST.

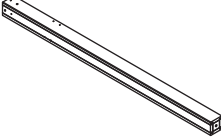
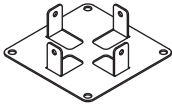
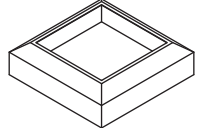
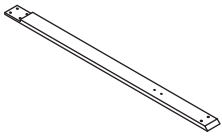
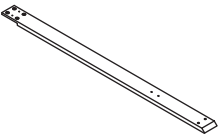
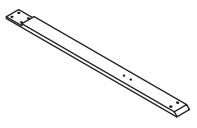
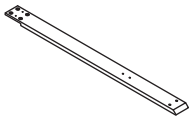
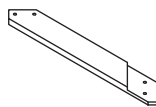
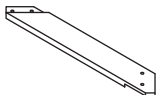

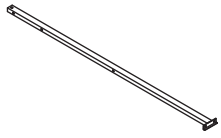
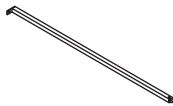
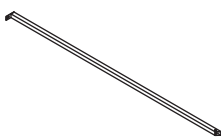
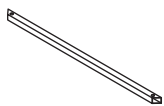
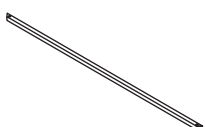
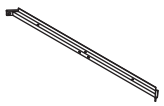
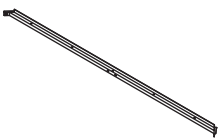
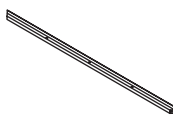
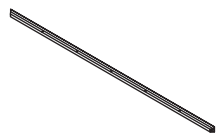
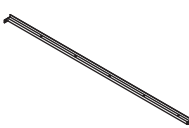
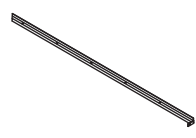
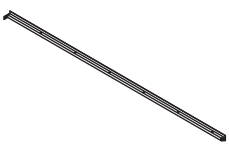
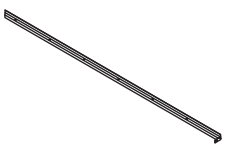
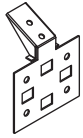
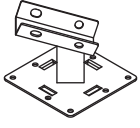
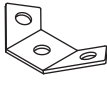
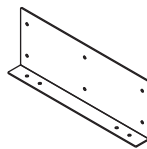
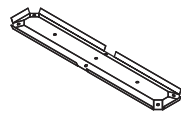
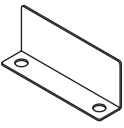
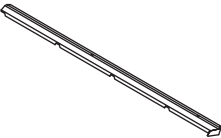
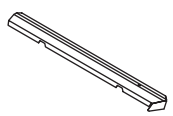
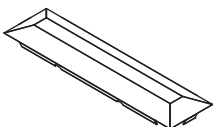
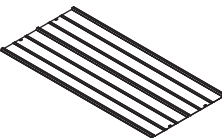
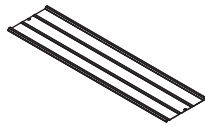
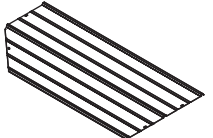

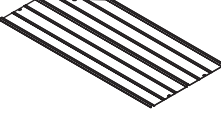
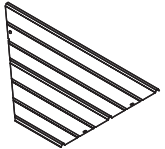
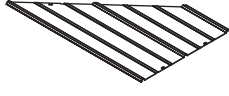
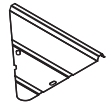
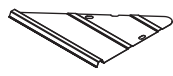
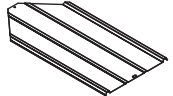
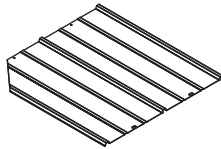
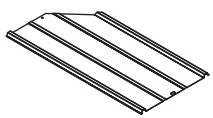
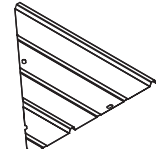
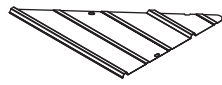

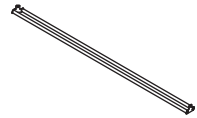
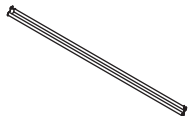
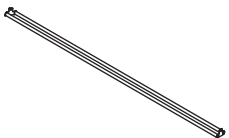
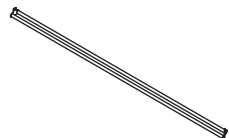

ASSEMBLY GUIDE

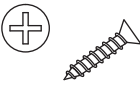
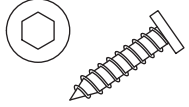
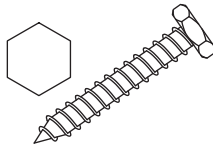
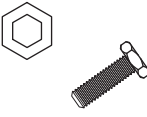
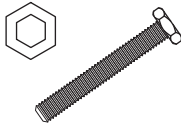
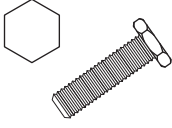
PARTS LIST

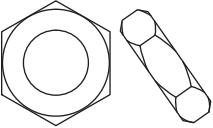
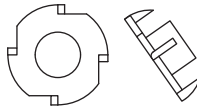
A1 Post 1 (4 pieces) 	B Foot Base (4 pieces) 	C Foot Cover (4 pieces) 	D1 Cross Beam 1 (2 pieces) 	D2 Cross Beam 2 (2 pieces) 	D3 Cross Beam 3 (2 pieces) 
P0010000701	P0030000301	P0020000301	P0040001501	P0040001601	P0040001701
D4 Cross Beam 4 (2 pieces) 	E1 Support Bracket 1 (4 pieces) 	E2 Support Bracket 2 (4 pieces) 	F1 Roof Rib 1 (4 pieces) 	F3 Roof Rib 3 (4 pieces) 	G1 Middle Cross Beam 1 (4 pieces) 
P0040001801	P0050000501	P0050000601	P0070000202	P0070000701	P0080000601
H5 Roof Support 5 (4 pieces) 	H6 Roof Support 6 (4 pieces) 	H9 Roof Support 9 (2 pieces) 	H10 Roof Support 10 (2 pieces) 	J3 Roof Upper Border 3 (2 pieces) 	J4 Roof Upper Border 4 (2 pieces) 
P0090002301	P0090002401	P0090002701	P0090002801	P0090003301	P0090003401
K3 Roof Top Border 3 (2 pieces) 	K4 Roof Top Border 4 (2 pieces) 	L5 Roof Border 5 (2 pieces) 	L6 Roof Border 6 (2 pieces) 	L7 Roof Border 7 (2 pieces) 	L8 Roof Border 8 (2 pieces) 
P0090003701	P0090003801	P0090003901	P0090004001	P0090004101	P0090004201
M1 Connector 1 (4 pieces) 	M3 Connector 3 (4 pieces) 	M5 Connector 5 (16 pieces) 	M6 Connector 6 (4 pieces) 	M8 Connector 8 (1 piece) 	M9 Connector 9 (4 pieces) 
P0060001401	P0060001701	P0060000602	P0110000701	P0060000702	P0110000502
N1 Roof Rib Cover 1 (4 pieces) 	N3 Roof Rib Cover 3 (4 pieces) 	N4 Roof Rib Cover 4 (1 piece) 	P6 Roof Plate 6 (2 pieces) 	P7 Roof Plate 7 (4 pieces) 	P8 Roof Plate 8 (4 pieces) 
P0120000102	P0120001201	P0120001401	P0130000102	P0130002001	P0130000202

<p>P9 Roof Plate 9 (4 pieces)</p> 	<p>P10 Roof Plate 10 (4 pieces)</p> 	<p>P11 Roof Plate 11 (4 pieces)</p> 	<p>P12 Roof Plate 12 (4 pieces)</p> 	<p>P13 Roof Plate 13 (4 pieces)</p> 	<p>Q1 Roof Top Plate 1 (2 pieces)</p> 
<p>P0130000302</p>	<p>P0130000402</p>	<p>P0130000502</p>	<p>P0130000602</p>	<p>P0130000702</p>	<p>P0130002501</p>
<p>Q5 Roof Top Plate 5 (2 pieces)</p> 	<p>Q6 Roof Top Plate 6 (2 pieces)</p> 	<p>Q7 Roof Top Plate 7 (4 pieces)</p> 	<p>Q8 Roof Top Plate 8 (4 pieces)</p> 	<p>R Hook (1 piece)</p> 	<p>T3 Mosquito Net Rod 3 (2 pieces)</p> 
<p>P0130002901</p>	<p>P0130003001</p>	<p>P0130001302</p>	<p>P0130001402</p>	<p>P1000000100</p>	<p>P0100001001</p>
<p>T4 Mosquito Net Rod 4 (2 pieces)</p> 	<p>T5 Mosquito Net Rod 5 (2 pieces)</p> 	<p>T6 Mosquito Net Rod 6 (2 pieces)</p> 			
<p>P0100001101</p>	<p>P0100001201</p>	<p>P0100001301</p>			

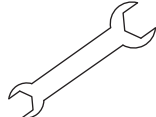
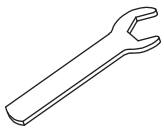
HARDWARE

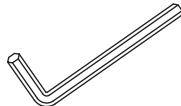
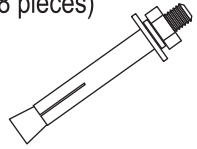
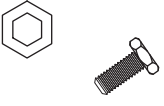
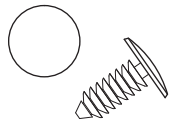
AA Self-tapping Bolt M5*25 (88+4 pieces)	BB Self-tapping Bolt M8*35 (32+2 pieces)	CC Self-tapping Bolt M10*65 (8+1 pieces)	DD Bolt M6*20 (180+9 pieces)	EE Bolt M6*45 (14+1 pieces)	FF Bolt M8*30 (16+1 pieces)
					
H0008008098	H0008008099	H0008008100	H0008008036	H0008008016	H0008008139
GG Bolt M10*160 (8+1 pieces)	HH Anti-slip Screw Nut M10 (8+1 pieces)	JJ Four-claw Screw Nut M8*8 (16+2 pieces)	KK M6 Flat washer (234+11 pieces)	LL M8 Flat washer (48+3 pieces)	MM M10 Flat washer (24+2 pieces)
					
H0008008140	H0008008126	H0008008127	H0008008056	H0008008057	H0008008058
NN M6 Sealant Washer (12+1 pieces)	PP Double Open End Wrench M6/M8 (2 pieces)	QQ Wrench M10 (2 pieces)	RR M6 Allen Key (2 pieces)	SS M8 Allen Key (2 pieces)	TT Concrete Anchor M6*60 (8 pieces)
					
H0008008060	H0008008062	H0008008128	H0008008073	H0008008129	H0008008095
UU Bolt M6*15 (40+2 pieces)	VV Plastic Clip (16+4 pieces)				
					
H0008008001	H0008008071				

IMPORTANT:

This instruction manual contains important information necessary for the proper assembly and safe use of the product.

Read and follow all warnings and instructions before assembling and using the product.

Follow all warnings and instructions when using the product.

Keep this manual for future reference.

Installer/Assembler: leave these instructions with the consumer.

SAFETY ALERT KEY

DANGER

Indicates a hazardous situation that, if not avoided, will result in death or serious injury.

WARNING

Indicates a hazardous situation that, if not avoided, could result in death or serious injury.

CAUTION

Indicates a hazardous situation that, if not avoided, could result in minor or moderate injury.

NOTICE

Indicates information considered important, but not hazard-related (e.g.messages related to property damage).

ASSEMBLY INSTRUCTIONS

- Please carefully unpack each of the components and hardware. check the components against the parts list and make sure there are no missing parts. lay pieces on cardboard or a soft mat to help protect the pieces from scratches.

⚠ CAUTION

Watch for sharp edges when handling the pieces, wear gloves to avoid injury.

STEP 01 Slide foot base **B** and foot cover **C** onto post **A1**. Use four (4) **[AA]** bolts to attach foot base **B** to post **A1**. Repeat with the other three (3) posts **A1**.

[AA] x 16

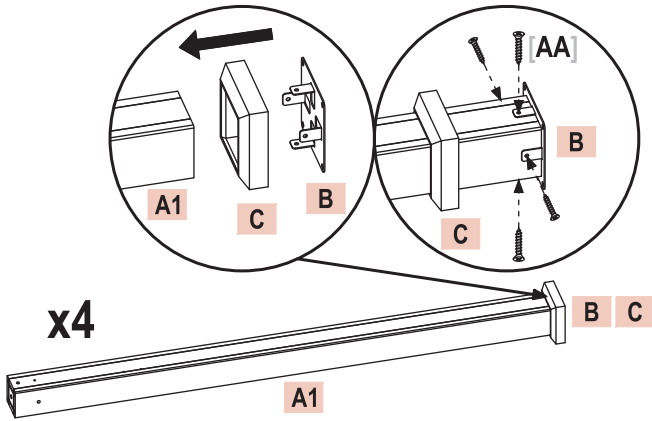

- For ease of assembly, it is recommended to have 3 or more people and allow enough time to completely finish the assembly. assembly can take 6-8 hours. a step-ladder is required for assembly (not included).
- Follow step by step instructions, and follow all safety warnings provided with your tools.
- DO NOT tighten screws until all the screws and washers are properly installed. tighten screws securely, do not over tighten.
- Gazebo should not be used in inclement weather and high winds.

STEP 02 Attach four (4) **[JJ]** screw nuts to each end of cross beam **D2**. Use four (4) **[FF]** bolts and four (4) **[LL]** flat washers to attach cross beam **D1** to connector **M1** and cross beam **D2**. Repeat with the other assembly. Attach four (4) **[JJ]** screw nuts to each end of cross beam **D4**. Use four (4) **[FF]** bolts and four (4) **[LL]** flat washers to attach cross beam **D3** to connector **M1** and cross beam **D4**. Repeat with the other assembly.

[FF] x 16

[LL] x 16

[JJ] x 16

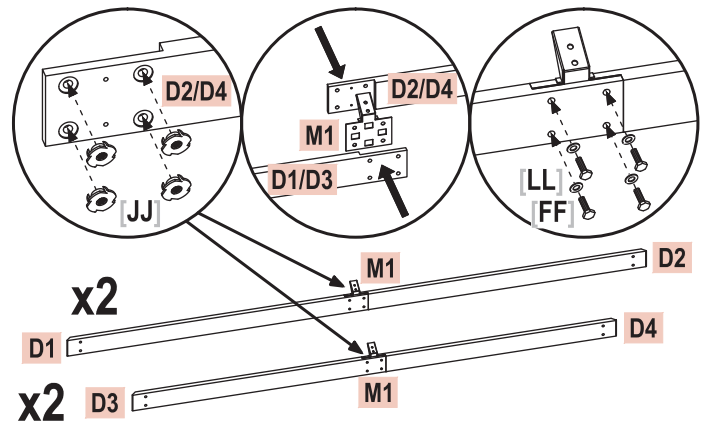

STEP 03 Use ten (10) **[AA]** bolts to attach one (1) connector **M6** to cross beam assembly **D1 D2** and **D3 D4**. Repeat with the other cross beam assembly **D1 D2** and **D3 D4**.

[AA] x 40

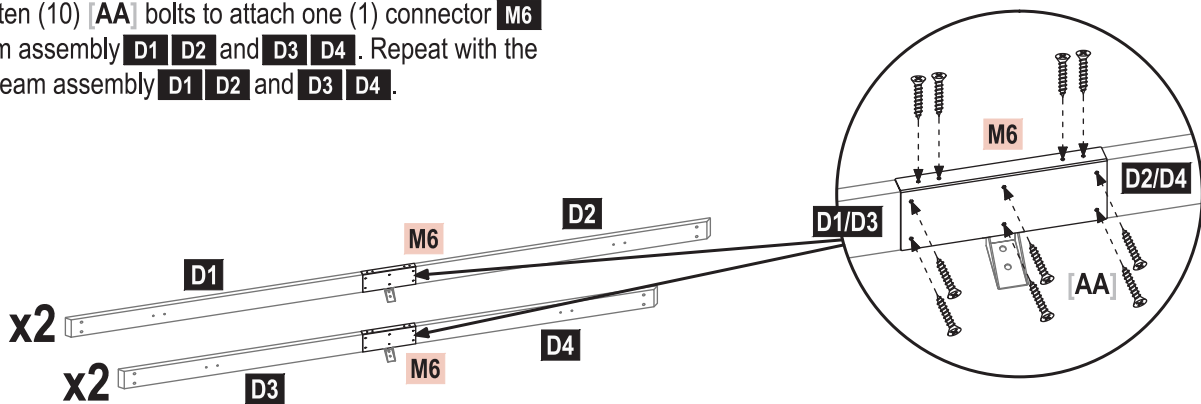

STEP 04 Attach the cross beam assembly **D1 D2** to left **A1** post using one (1) **[CC]** bolt and **[MM]** washer in the top hole, and one (1) **[GG]** bolt, two (2) **[MM]** washers, and one (1) **[HH]** nut in the bottom hole. Attach the cross beam assembly to right **A1** post using one (1) **[GG]** bolt, two (2) **[MM]** washers, and one (1) **[HH]** nut in the top hole, and one (1) **[CC]** bolt and **[MM]** washer in the bottom hole. Repeat to make a second assembly.

- [CC]** x 4
- [GG]** x 4
- [HH]** x 4
- [MM]** x 12

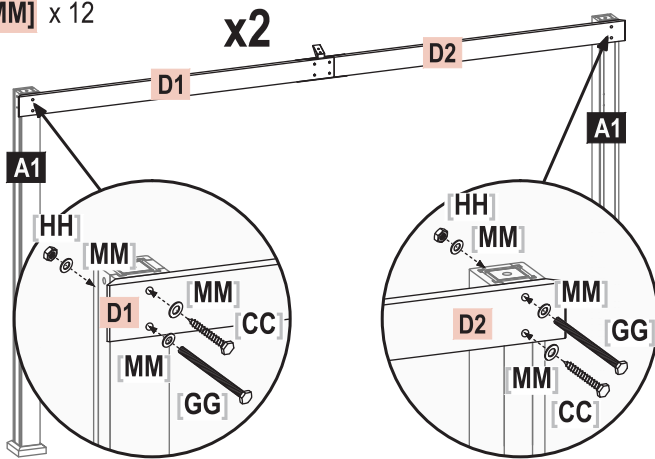

STEP 05 Attach the cross beam assembly **D3 D4** to left **A1** post using one (1) **[CC]** bolt and **[MM]** washer in the top hole, and one (1) **[GG]** bolt, two (2) **[MM]** washers, and one (1) **[HH]** nut in the bottom hole. Attach the cross beam assembly to right **A1** post using one (1) **[GG]** bolt, two (2) **[MM]** washers, and one (1) **[HH]** nut in the top hole, and one (1) **[CC]** bolt and **[MM]** washer in the bottom hole. Repeat to make a second assembly.

- [CC]** x 4
- [GG]** x 4
- [HH]** x 4
- [MM]** x 12

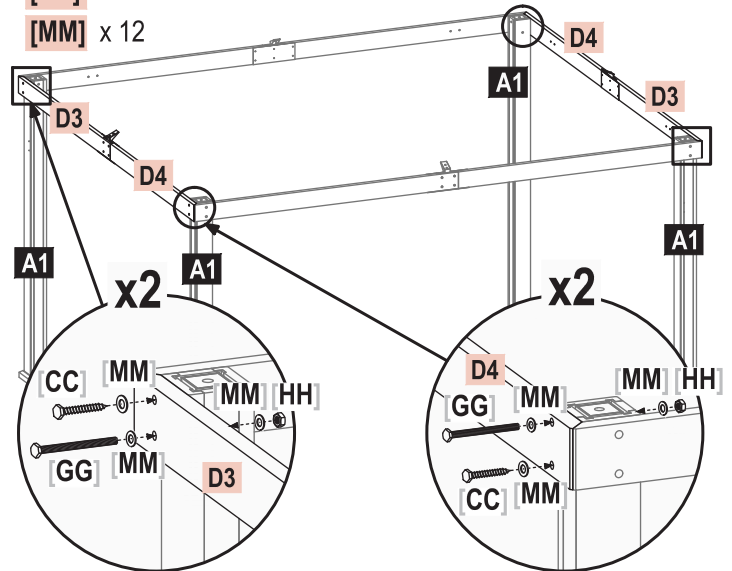

STEP 06

CRITICAL: SQUARE UNIT BEFORE PROCEEDING TO NEXT STEPS. ONCE SQUARE, TIGHTEN ALL HARDWARE.

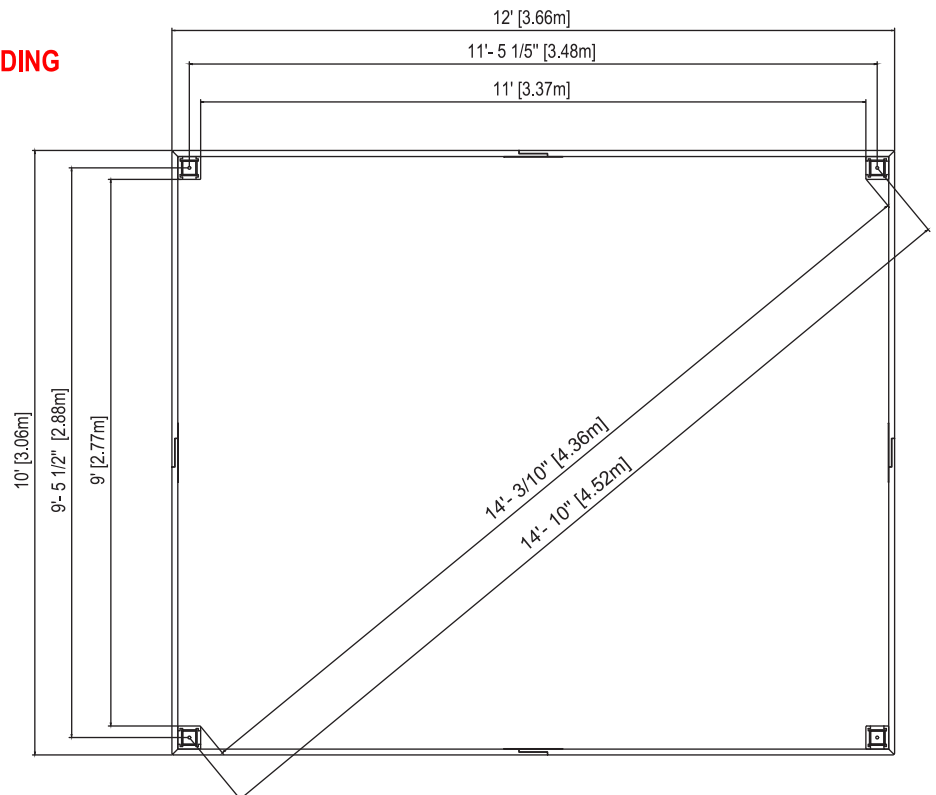

STEP 07 Use four (4) [BB] bolts and four (4) [LL] flat washers to attach one (1) support bracket [E1] to cross beam and post on left corner of each side. Repeat with the other three (3) support brackets [E1].

Use four (4) [BB] bolts and four (4) [LL] flat washers to attach one (1) support bracket [E2] to cross beam and post on right corner of each side. Repeat with the other three (3) support brackets [E2].

[BB] x 32

[LL] x 32

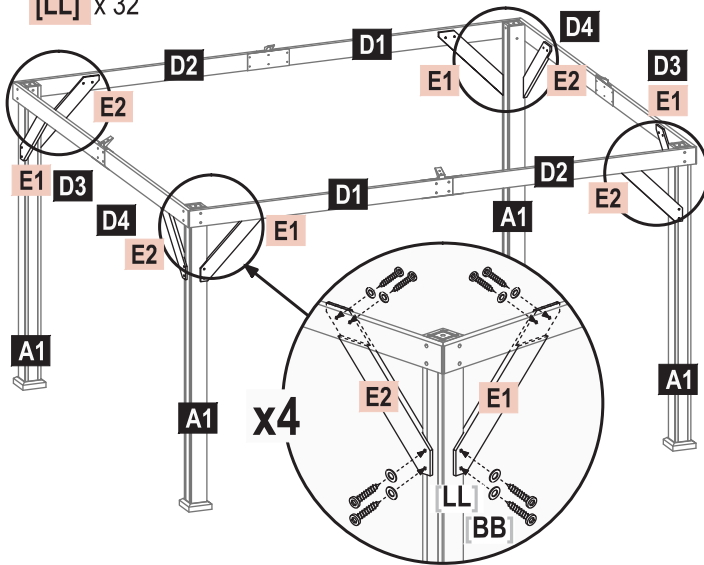

STEP 08 Use eight (8) [AA] bolts to attach one (1) connector [M3] to post [A1]. Repeat with the other three (3) connector [M3].

[AA] x 32

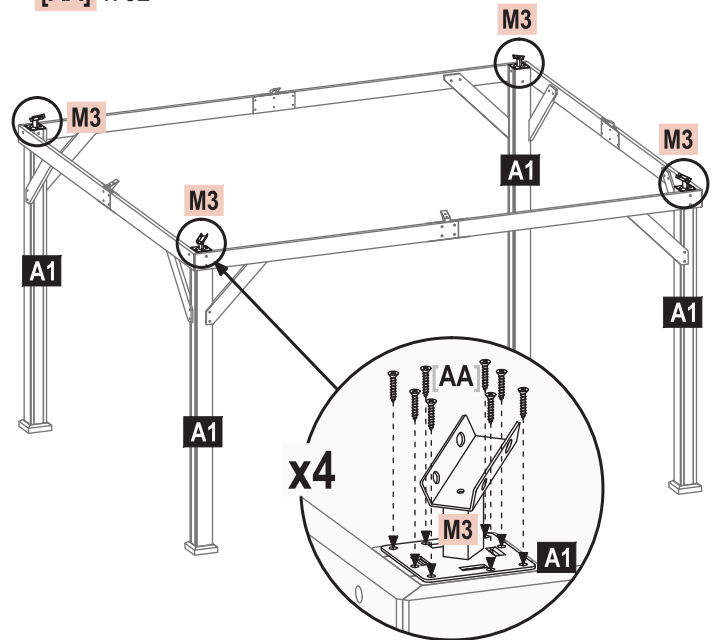

STEP 09 Use two (2) [DD] bolts and two (2) [KK] flat washers to attach roof rib [F1] to connector [M3]. Repeat with the other three (3) roof rib [F1].

[DD] x 8

[KK] x 8

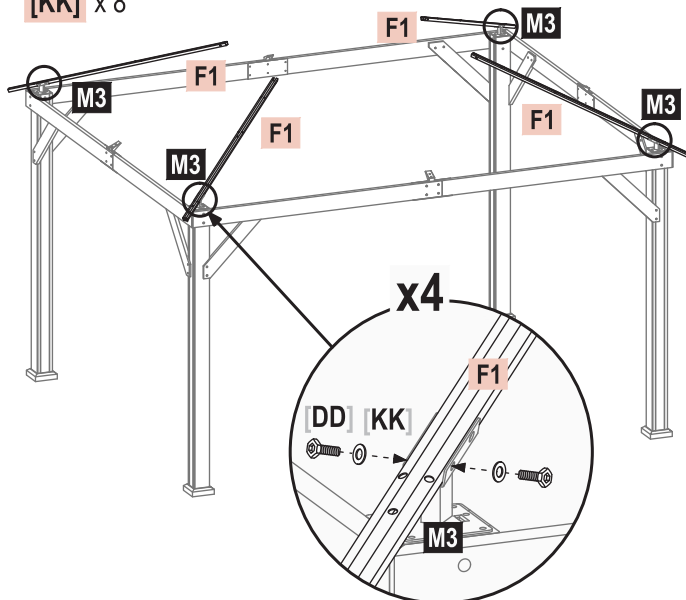

STEP 10 Slide roof rib [F3] into [F1]. Use four (4) [DD] bolts and four (4) [KK] flat washers to attach connector [M8] to roof ribs [F3].

[DD] x 4

[KK] x 4

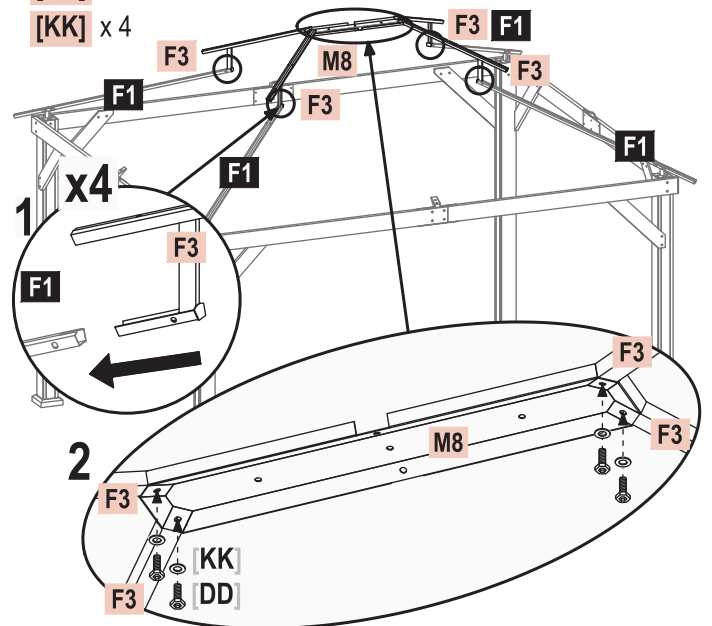

STEP 11 Use one (1) [DD] bolt and one (1) [KK] flat washer to attach one (1) connector [M5] to roof rib [F1] and [F3]. Repeat with the other three (3) connector [M5] on one [F1] [F3]. Repeat with the other three (3) roof rib [F1] [F3].

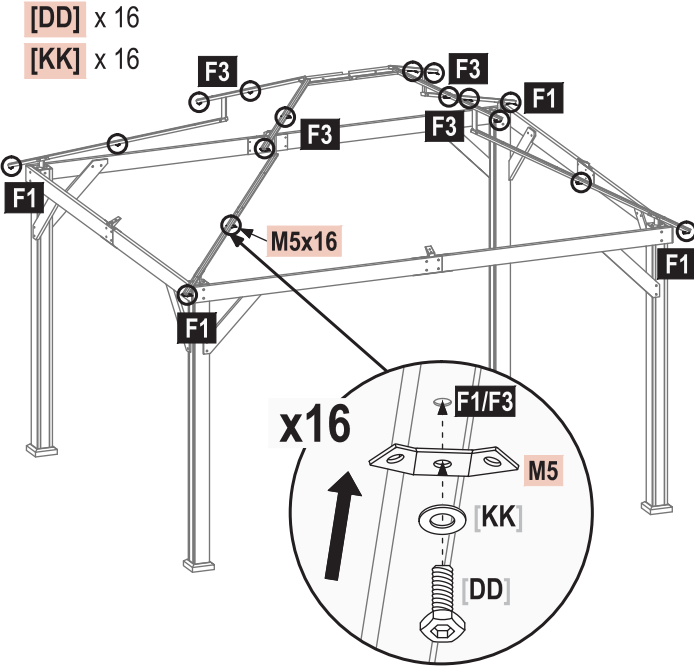

STEP 12 Use two (2) [DD] bolts and two (2) [KK] flat washers to attach one (1) roof upper border [J3] to roof rib [F1] [F3]. Repeat with the other [J3]. Use two (2) [DD] bolts and two (2) [KK] flat washers to attach one (1) roof upper border [J4] to roof rib [F1] [F3]. Repeat with the other [J4].

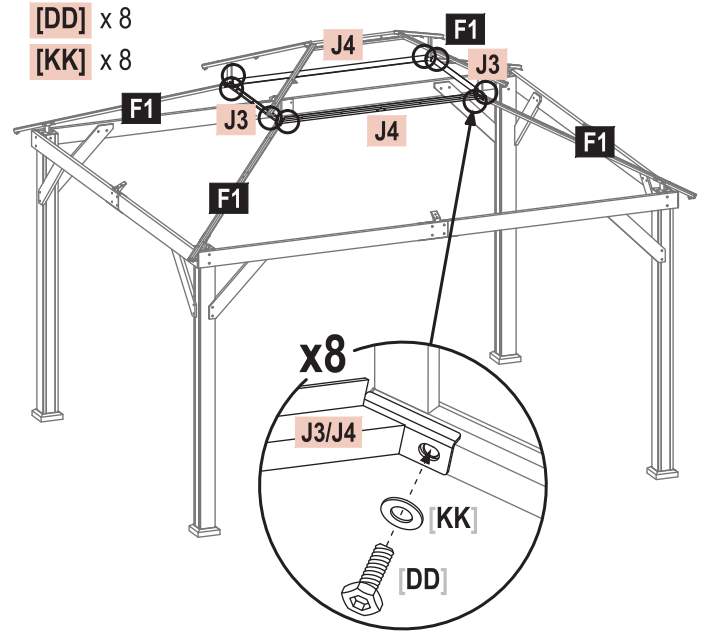

STEP 13 Use two (2) [DD] bolts and two (2) [KK] flat washers to attach one end of middle cross beam [G1] to roof upper border [J3] / [J4]. Use two (2) [DD] bolts and two (2) [KK] flat washers to attach the other end of middle cross beam [G1] to connector [M1]. Repeat with the other three (3) [G1].

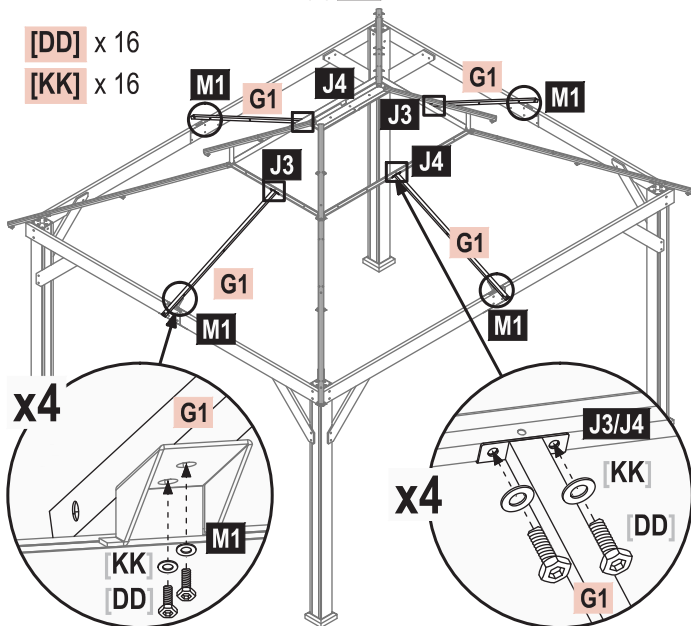

STEP 14 Use one (1) [DD] bolt, one (1) [UU] bolt and two (2) [KK] flat washers to attach one (1) mosquito net rod [T3] to middle cross beam [G1] and roof rib [F1]. Repeat with the other [T3], two (2) [T4], two (2) [T5] and two (2) [T6].

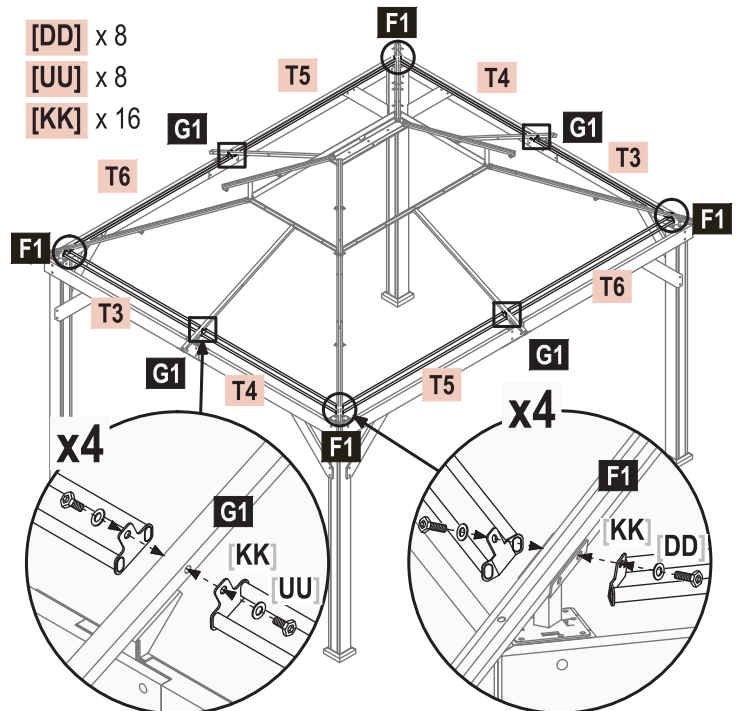

STEP 15 Use two (2) [UU] bolts and two (2) [KK] flat washers to attach one (1) roof support **H9** to connector **M5**. Repeat with the other **H9**.

Use two (2) [UU] bolts and two (2) [KK] flat washers to attach one (1) roof support **H10** to connector **M5**. Repeat with the other **H10**.

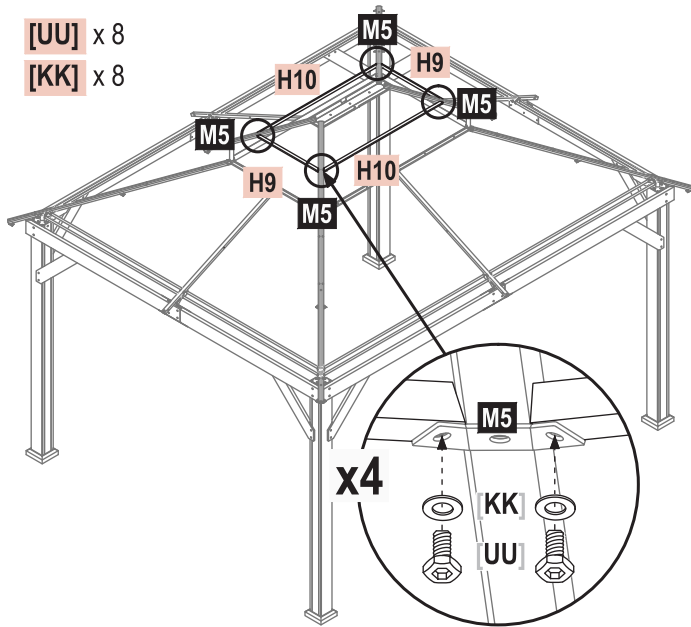

STEP 16 Use two (2) [DD] bolts and two (2) [KK] flat washers to attach one (1) roof top border **K3** to connector **M5**. Repeat with the other **K3**.

Use two (2) [DD] bolts and two (2) [KK] flat washers to attach one (1) roof top border **K4** to connector **M5**. Repeat with the other **K4**.

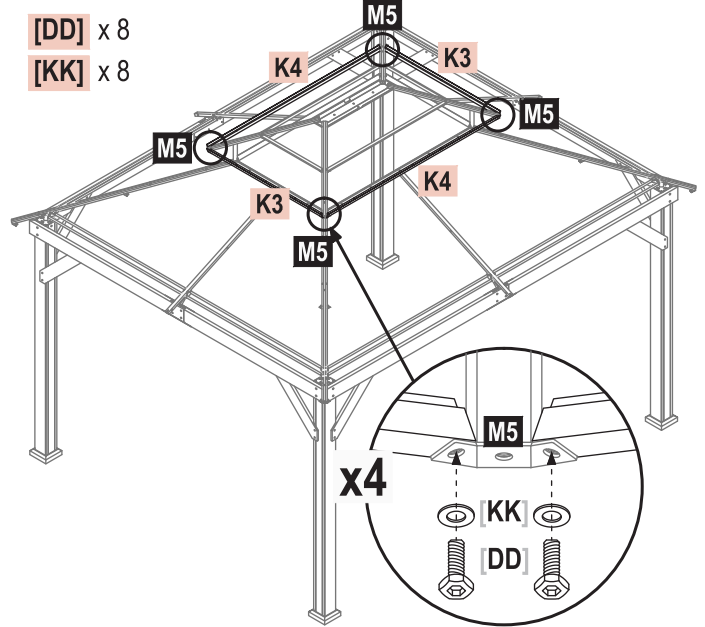

STEP 17 Use two (2) [UU] bolts and two (2) [KK] flat washers to attach one (1) roof support **H5** to connector **M5** and middle cross beam **G1**. Repeat with the other three (3) **H5**.

Use two (2) [UU] bolts and two (2) [KK] flat washers to attach one (1) roof support **H6** to connector **M5** and middle cross beam **G1**. Repeat with the other three (3) **H6**.

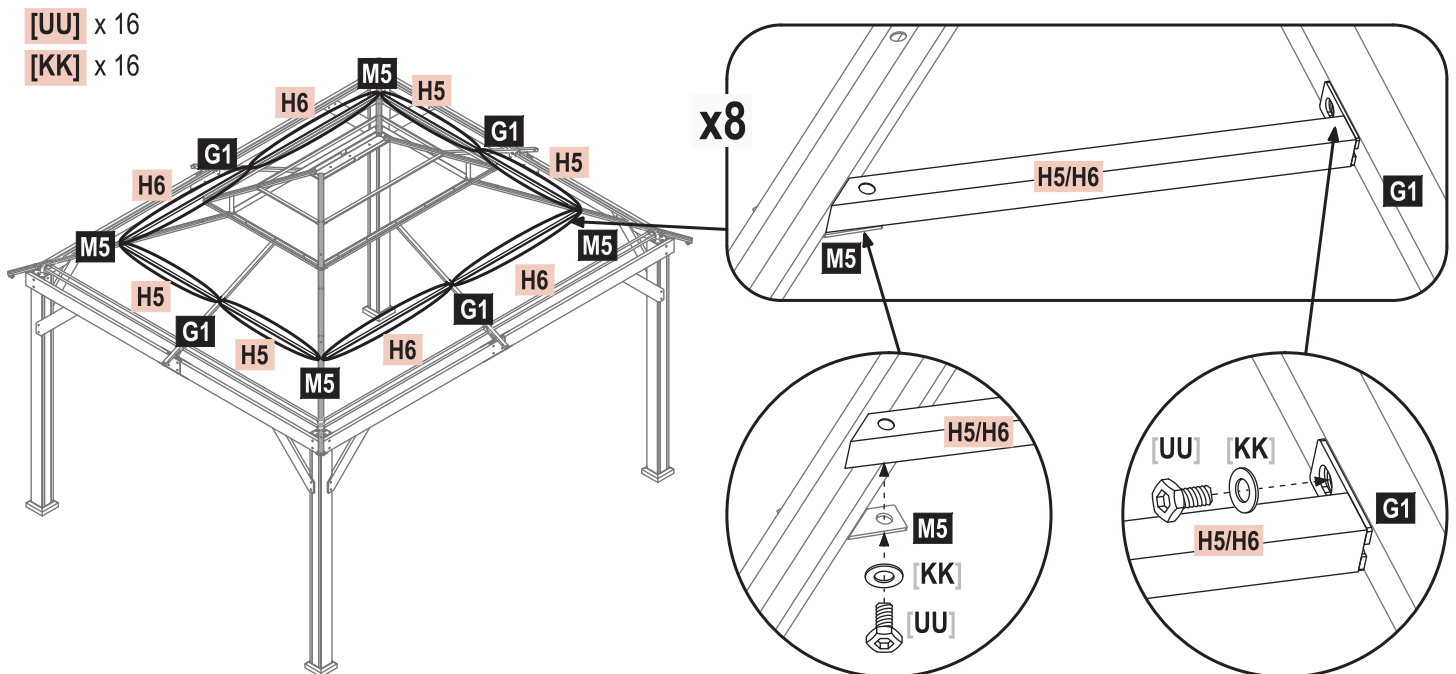

STEP 18 Use one (1) [UU] bolt, one (1) [DD] bolt and two (2) [KK] flat washers to attach one (1) roof border [L5] to connector [M5] and middle cross beam [G1]. Repeat with the other [L5], two (2) [L6], two (2) [L7], two (2) [L8].

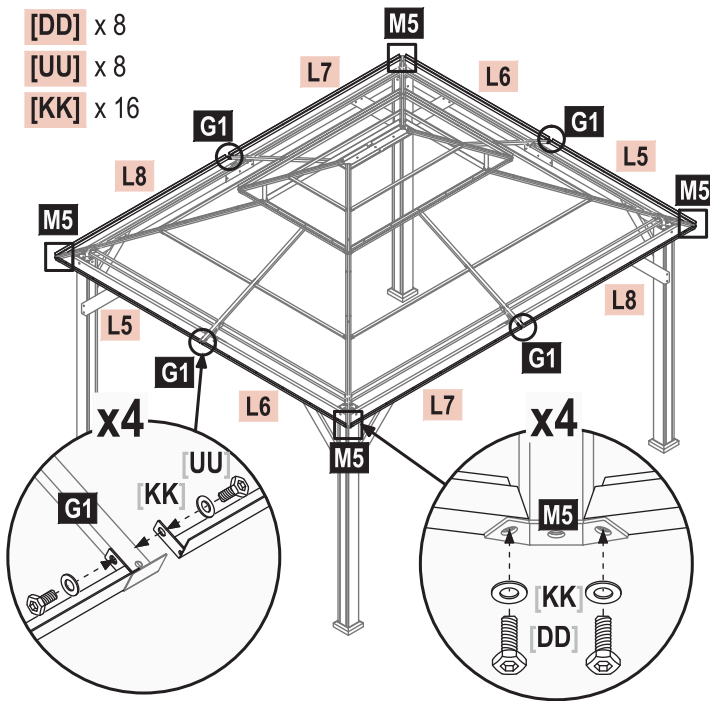

STEP 19 Use two (2) [DD] bolts and two (2) [KK] flat washers to attach one (1) connector [M9] to roof border assembly [L5] [L6]. Repeat with the other three (3) connector [M9] to roof border assembly [L5] [L6] and roof border assembly [L7] [L8].

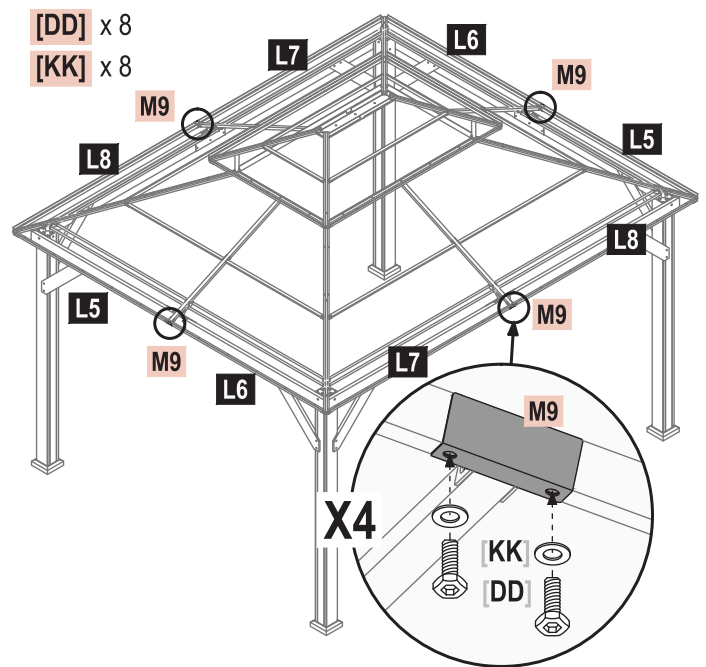

STEP 20 DO NOT tighten the bolts completely until all the bolts and washers are properly installed.

Overlap the edges of the adjacent roof plates together.

Use one (1) [DD] bolt and one (1) [KK] flat washer to attach each hole of roof top plates [Q1], [Q5], [Q6], [Q7], [Q8] to the top frame.

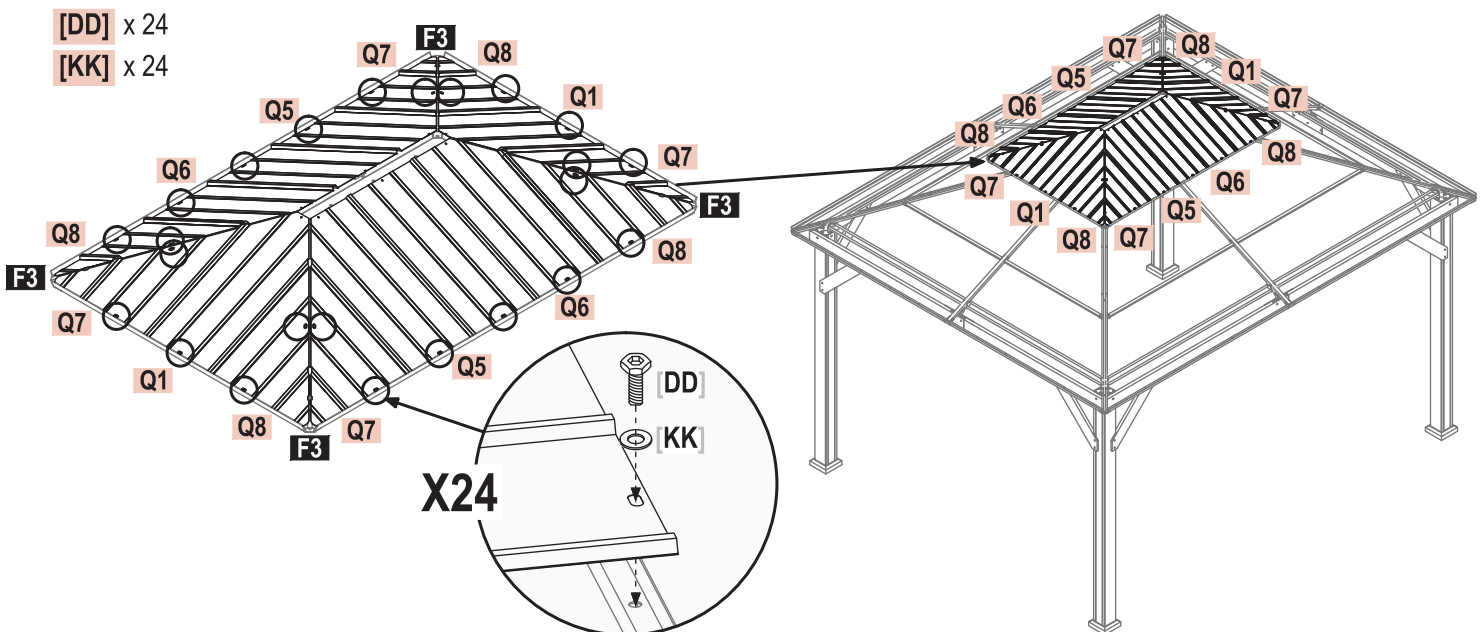

STEP 21 Use one (1) [EE], one (1) [KK] flat washers and one (1) [NN] flat washer to attach one (1) roof rib cover [N3] to the top roof. Repeat with the other three (3) roof rib cover [N3].

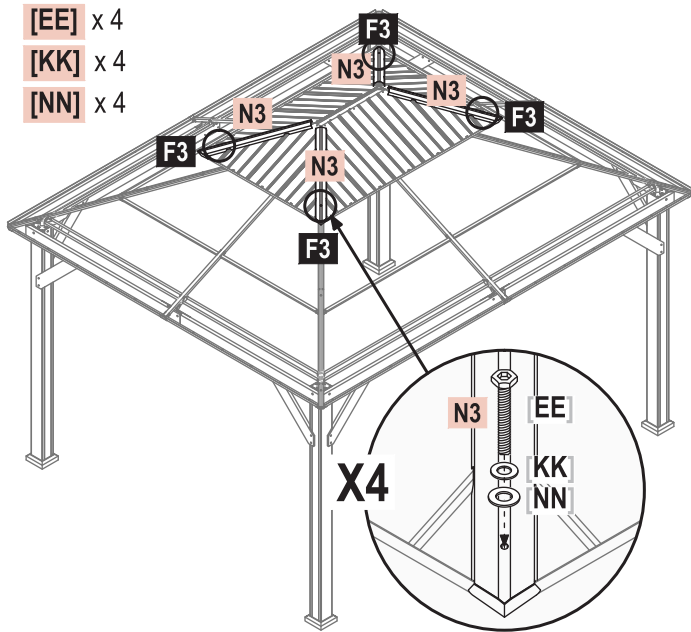

STEP 22 Use two (2) [EE], two (2) [KK] flat washers to and one (1) hook [R] to attach roof rib cover [N4] to connector [M8].

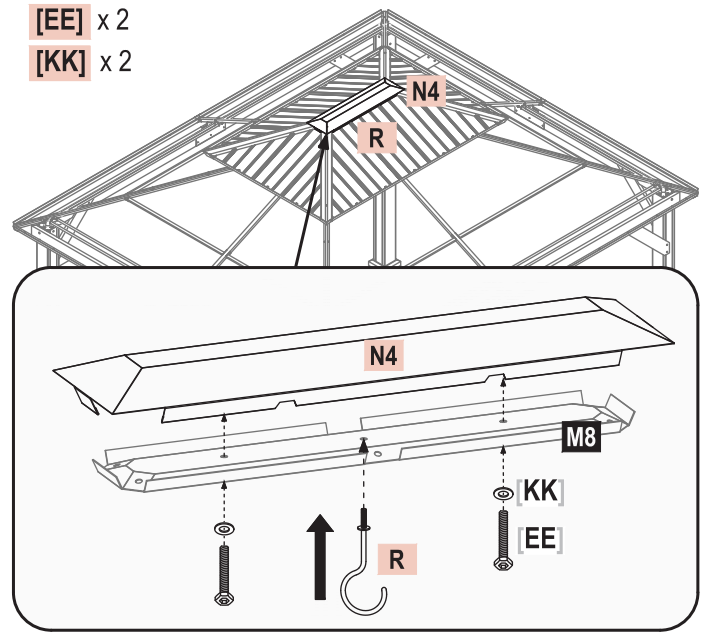

STEP 23 DO NOT tighten the bolts completely until all the bolts and washers are properly installed.

Overlap the edges of the adjacent roof plates together.

Use one (1) [VV] bolt to attach each hole on upper end of roof plates [P6, P7, P8, P9, P10, P11, P12, P13] to the frame.

Use one (1) [DD] bolt and one (1) [KK] flat washer to attach each hole on lower end of roof plates [P6, P7, P8, P9, P10, P11, P12, P13] to the frame.

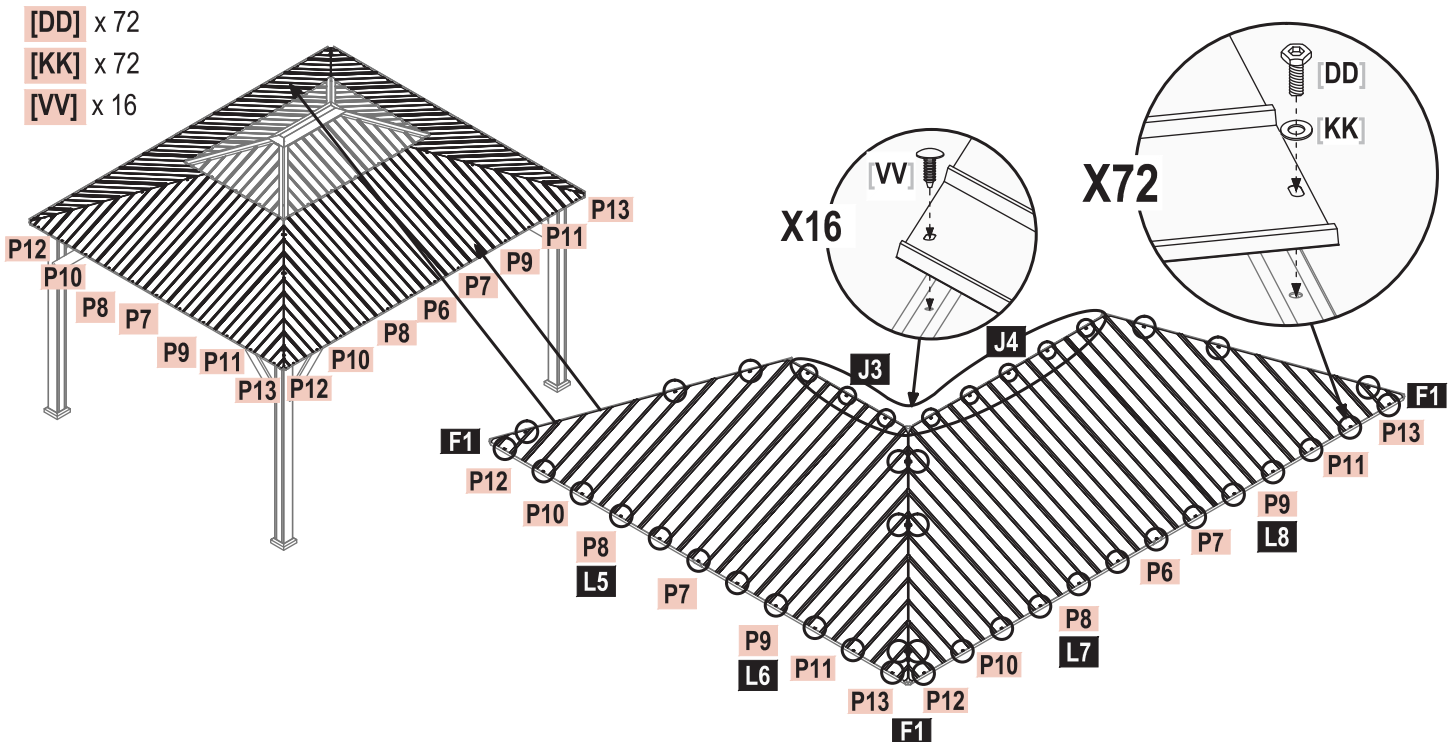

STEP 24 Use two (2) [EE], two (2) [KK] flat washers and two (2) [NN] flat washers to attach one (1) roof rib cover [N1] to the roof. Repeat with the other three (3) roof rib cover [N1].

- [EE] x 8
- [KK] x 8
- [NN] x 8

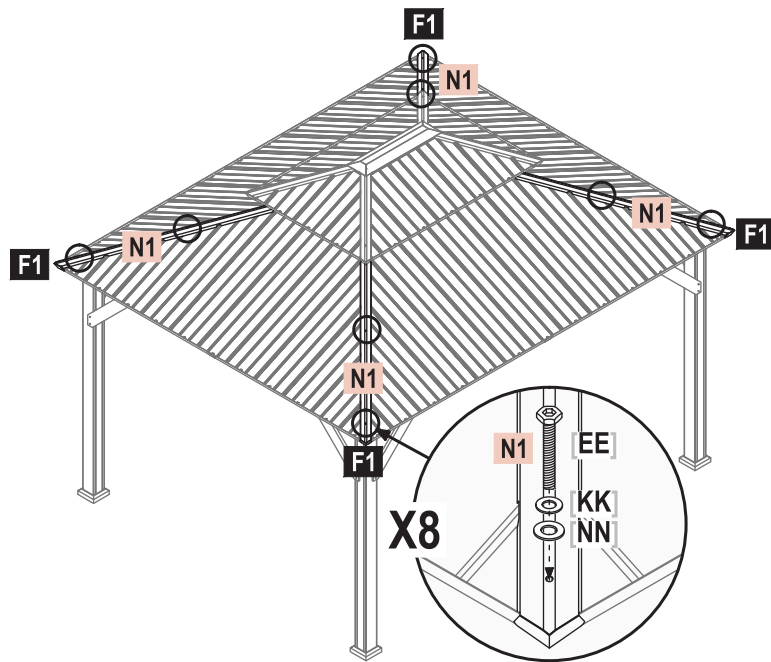

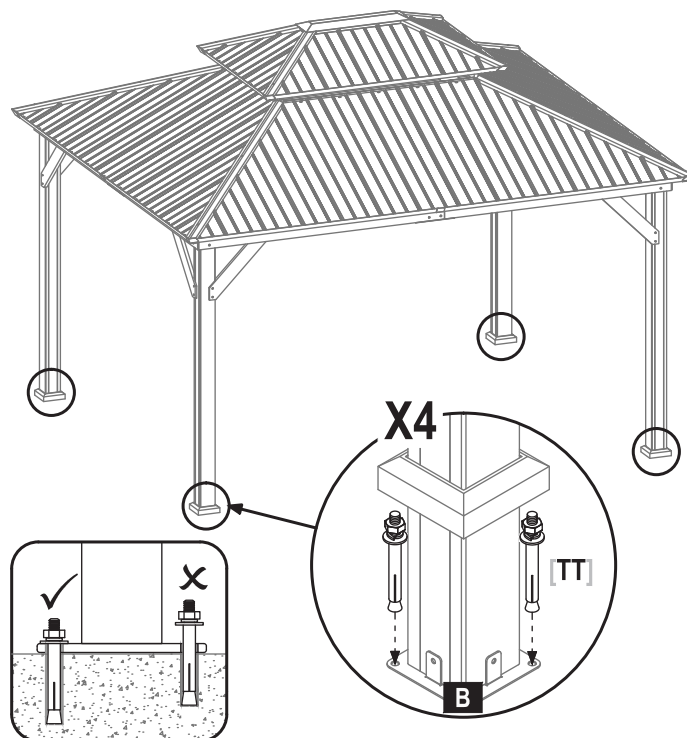

STEP 25 Use two (2) [TT] expansion bolts to anchor each post foot base [B]. please make sure the expansion bolts are fully anchored.

- [TT] x 8

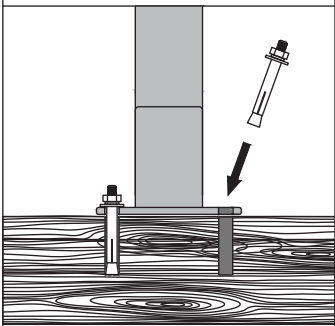
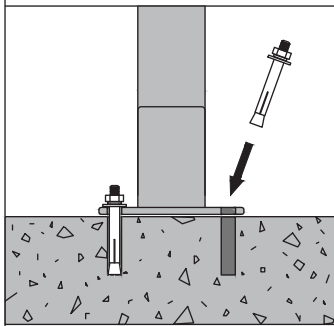

Outdoor Structure anchoring guide for anchoring gazebo to wood or concrete: If step 25, on page 12 in the assembly instructions is not properly completed, this will void the warranty.

WARNING! If your gazebo is not properly anchored, damage could occur. It is highly recommended for maximum safety that you mount and secure to wood or concrete footers. This is far better and safer than using ground stakes. The following are some examples of how to mount the structure to wood or concrete surfaces. Refer to local building codes or consider consulting a licensed contractor for assistance in the anchoring of this product.

WOOD	CONCRETE
	
<p>Anchors should be drilled into joists or reinforced blocking (not only deck boards).</p>	<p>Pre-drill holes for appropriately sized concrete anchors.</p>
 <p>Recommended Hardware: Expansion Bolt</p>	 <p>Recommended Hardware: Expansion Bolt</p>

If digging for foundation, please double check for possibility of any underground utilities such as gas, telephone, cable or sprinkler lines. Refer to your local building and city codes, ordinances, neighborhood covenants, or height restrictions regarding this type of structure for guidance on acceptable installation requirements.

CAUTION
DO NOT climb or walk on roof for any reason.

- Our components are intended for privacy, decorative and ornamental use only.
- Product is NOT INTENDED for the following:
 - A safety barrier to prevent unsupervised access to pools, hot tubs, spas or ponds.
 - As load bearing support for a building, structure, heavy objects or swings.
 - Used in structures that trap wind, rain or snow that would create extra load on the product.
 - Accumulated snow must be removed from roof.
 - DO NOT climb or walk on roof for any reason.

LIMITED WARRANTY

We warrants this product against defects in materials and workmanship for a period of one (1) year from the original date of purchase. To the extent any such defects occur, our products will send the appropriate replacement part(s) at no charge.

This warranty does not cover:

- Inspection costs or labor for replacement of any defective parts);
- Incidental or consequential damages;
- Cosmetic defects which DO NOT affect performance;
- Normal wear and tear;
- Damage due to vandalism; acts of nature, including but not limited to wind, storms, hail, floods;
- Improper assembly, installation, or use;
- Discoloration or fading of the finish as a result of exposure to chemicals, spills, pool or salt water
- Corrosion/ rust.

Your product has been designed for safety and quality.

Any modifications made to the original product could compromise its structural integrity or function, and could lead to product failure or personal injury. As such, modifying this product voids any and all warranties.

This product is warranted for RESIDENTIAL USE ONLY, and is not for commercial, contract or other non-residential purposes. Products disclaims all other representations and warranties of any kind, express or implied.

The warranty applies to the original purchaser and is non-transferable. It does not apply to purchases of display models, or when the product is sold on clearance or "as is".

We makes no warranty whatsoever in respect to accessories or parts not supplied with it. This warranty shall apply only within the boundaries of the United States of America and Canada. This warranty gives the original purchaser specific rights, and the original purchaser may also have other rights, which vary from state to state.

